

Article number: 46932513

Description: Torque limiter Synchron A 25 L

Measures

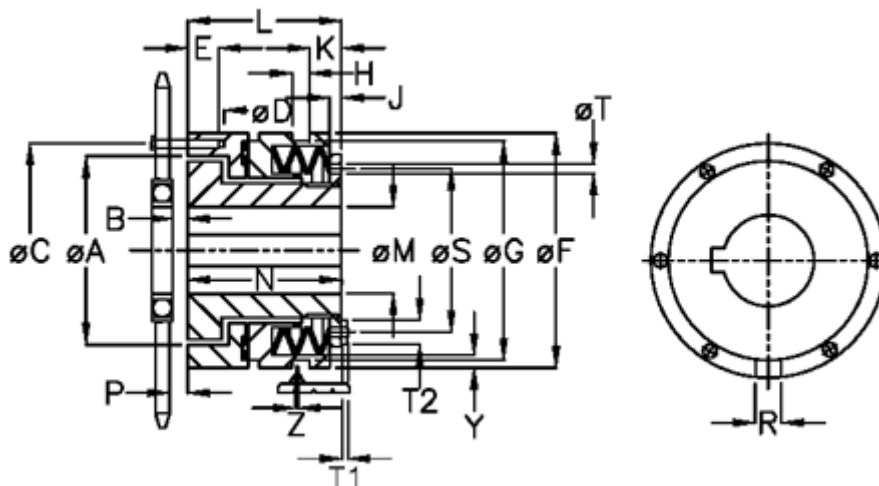

A	= 60.0	G	= 73.0	P	= 3.0
B	= 4.0	H	= 9	R	= 6
C	= 70	J	= 6.0	S	= 48
D	= 6xM5	K	= 12.0	T	= 5
Disc spring mounting	= 5x1L	L	= 52.0	T1	= 4.0
Disc spring version	= L - heavy	M max	= 25	T2	= 8
E	= 8.0	M min	= 10	Y	= 2
F	= 82	N	= 48.0	Z	= 0.0